

INFOCUS

ISSUE
30

HKUST ENGINEERING SPRING 2019

Rise of the Robots

Smart Automation
in the Greater Bay Area



CONTENTS

SPRING 2019 | NO.30

5

HKUST expands
Branch campus planned
near Guangzhou

22

Driving the future
Experiential outreach
draws in future innovators

10

Robotics comes of age
Academic-entrepreneur's
smart way to automation

24

Dream team
Students set sights on devising
hi-tech products

14

Ready for Generation Z
Division with designs
on integrative systems

29

Environmental
education lessons
Alumna motivates next generation
to prioritize sustainability



18

Bridging the gender gap
Women engineering faculty
champion careers in academia

HKUST Engineering
In Focus Magazine
sengpr@ust.hk
(852) 2358 5917
www.seng.ust.hk/web/eng/publication.php

Published by:
Communications and External Affairs
School of Engineering
The Hong Kong University of
Science and Technology

Editors: Diana Liu, Dorothy Yip
Contributing Editor: Sally Course
Designer: Kingsley Lau

 [hkustengineering](https://www.facebook.com/hkustengineering)
 [hkustengineering](https://www.instagram.com/hkustengineering)
 seng.ust.hk



Advancing innovation

Looking back at 2018, it has clearly been an amazing 12 months, filled with new beginnings and fresh endeavors at the School of Engineering (SENG).

The launch of the SENG-managed, University-wide Division of Integrative Systems and Design was a proud occasion. We also welcomed the first cohorts in several innovative undergraduate programs that span different departments, Schools, or address knowledge economy needs. Both developments are set to broaden the skill sets of our graduates to answer the burgeoning demand in fields such as robotics and autonomous systems, data analysis, and sustainable energy, as reported in our cover story and other articles in this issue of *In Focus*.

The School's strong global reputation for research and talented graduates has also led to a large number of collaborations with industry over the past year. We will be seeking to extend this in the year ahead, not just through joint laboratories but deeper understanding of where our discoveries and applications can be most impactful to society and companies.

Such moves will help to ensure that SENG remains at the forefront of our fast-changing times, as an academic leader of engineering education, an explorer of novel frontiers, and a solution-builder to global challenges.

As such, the School is set to play a major role in HKUST's recently announced campus to be constructed near Guangzhou. This major University initiative will initially

focus on multidisciplinary programs and postgraduate education and seek to underpin cutting-edge science and technology development in the Greater Bay Area, a national strategic development plan comprising Hong Kong, Macau, and neighboring cities.

Working or undertaking an education in such a dynamic environment and area of the world, where investment in science and technology is receiving greater emphasis from both government and industry, and enthusiasm for new knowledge and making a difference is high, makes the School a highly satisfying place to call home.

Our 10% expansion of faculty members is underway. But in growth, our goal is not just size. Rather, we vigorously seek to fuel expanded scope and vision in emerging areas where we expect to excel, and society needs such expertise and talents to move on.

In 2019 and beyond, I look forward to such an approach, and the many exciting opportunities opening up in the School and this part of the world, energizing our students, faculty, alumni, and staff to further new beginnings, achievement, and contribution.

Prof. Tim CHENG Kwang-Ting
Dean of Engineering

Heading for fresh heights

Prof. Wei SHYY was installed as the fourth President of HKUST in November during the University's 26th Congregation.

In his installation address, Prof. Shyy, previously the University's Executive Vice-President and Provost, spoke about the global challenges facing humanity, including sustainability, unequal opportunities, population aging, and wealth distribution.

He noted how the role of universities had evolved from elite institutions to entities responsible for advancing social, economic and human development through the originality in reasoning, discovery and innovation they championed and their general principles of being "apolitical, open, and encouraging to everyone".

Given HKUST's emphasis on science and technology, and the positive impact that such fields have had on improving lives across society, he saw a leading role for the University in the future.

The President also paid tribute to the late Dr. CHUNG Sze-Yuen, Founding Council Chairman of HKUST and a key figure in the planning and establishment of the University in the 1980s and 1990s (see article below).

Prof. Shyy is a renowned aerospace engineering researcher, educator, and administrator. Originally from Taiwan, he undertook his master's and doctoral studies at the University of Michigan, Ann Arbor, in the US. His subsequent research career has involved pioneering studies into computational fluid dynamics, combustion

and propulsion, including space transport. Prof. Shyy is the author or co-author of five books and over 450 publications. He is a Fellow of the American Institute of Aeronautics and Astronautics and the American Society of Mechanical Engineers.



President Prof. Wei Shyy was installed in November.



In remembrance

In November, HKUST was profoundly saddened by the passing of Dr. CHUNG Sze-Yuen, who served as Chairman of the University's Planning Committee (1986-1988) and first Council Chairman (1988-1999).

Dr. Chung, an engineer turned politician, foresaw the need for a science and technology-focused university in Hong Kong in the 1980s to nurture the talent the city would need as it faced a fundamental shift from manufacturing to a service and knowledge-based economy, as well as reunification with Mainland China in 1997.

Expanding horizons

In a major initiative for the future development of HKUST, plans for a new campus in Guangdong Province were announced in October, with the School of Engineering set to play a major role.

The branch campus will be located near Guangzhou and, at 1.13 square kilometers, will be twice the size of the existing Clear Water Bay campus. It will initially concentrate on postgraduate education. Programs are expected to be thematic, solution-based, and cross-disciplinary, with thrust areas including sustainable energy and environment, robotics and autonomous systems, advanced materials and smart manufacturing, artificial intelligence and data science, and biomedicine and biomedical engineering.

Such programs resonate with the Greater Bay Area project, part of China's strategic national blueprint. The goal is to turn the special administrative regions of Hong Kong and Macau, together with nine neighboring cities in Guangdong, into an innovation and technology hub of global impact.

The campus will be located in Nansha, south of Guangzhou and adjacent to the Qingsheng station on the high-speed Guangzhou-Shenzhen-Hong Kong Express Rail Link, facilitating interaction with HKUST in Hong Kong. It will also be supported by HKUST Fok Ying Tung Research Institute, the University's existing knowledge transfer hub in Nansha.

The branch will be run as a separate entity, with construction costs and the future annual operating budget funded by the Guangzhou government. HKUST President



Looking ahead: HKUST's Guangzhou branch campus will offer thematic, solution-based programs.

Prof. Wei SHYY said 1,000 students would be enrolled in the first stage, gradually rising to around 10,000 at steady state.

Dean of Engineering Prof. Tim CHENG noted: "The additional site provides a great opportunity to complement – not duplicate – the current Clear Water Bay campus and there is no question that the School of Engineering will play a very important role."

The new campus will adhere to HKUST standards in teaching and learning, and academic policies. The medium of instruction will be English, and student and faculty recruitment will be global. As Mainland law requires a Mainland institution as a partner in such an undertaking, HKUST will partner with Guangzhou University.

After playing a key role in establishing the Hong Kong Polytechnic and City Polytechnic of Hong Kong (now Hong Kong Polytechnic University and City University of Hong Kong), he then led the initiative to create HKUST. The University was established in 1991.

In addition to his role as Council Chairman, Dr. Chung served as HKUST's Pro-Chancellor (1999-2011) and Chairman of the Court (1999-2008), subsequently retaining the title of Honorary Chairman.

Dr. Chung graduated with first class honors in mechanical engineering from the University of Hong Kong in 1941. He died at the age of 101.



Dr. Chung Sze-Yuen: led the initiative to found HKUST.

Robotics and AI roll ahead

Robotics and artificial intelligence research and human resources in Hong Kong and the Greater Bay Area were given a significant boost over the summer and fall with a series of forward-looking HKUST developments and activities.

A HK\$200 million donation from Guangdong Bright Dream Robotics, a subsidiary of Country Garden Holdings Company Limited, will support a professorship and scholarship program and other initiatives at the University in line with the company's vision to extend technology innovation and talents to build a "Robot Valley" in the Greater Bay Area.

HKUST is connecting up its expertise through a new center and other collaborations.

Internally, HKUST has set up the Center for Artificial Intelligence Research to spearhead holistic cross-disciplinary research in scientific, technological, social, business and education aspects of the field. The center, established in September, is the first of its kind at a university in Hong Kong.

Earlier in August, the University hosted the prestigious Xiangshan Science Conference, established by the State Science and Technology Commission (now Ministry of Science and Technology) and the Chinese Academy of Sciences. The two-day gathering focused on the theme of neuromorphic computing and artificial intelligence, drawing 40 leading scholars from Hong Kong, Macau and Mainland China.

Hong Kong's Chief Executive Mrs. Carrie LAM Cheng Yuet-Ngor and Deputy Directors of the Liaison Office of the Central People's Government in the HKSAR Mr. CHEN Dong and Dr. TAN Tieniu officiated at the conference's closing ceremony and witnessed the launch of the Hong Kong Society of Artificial Intelligence and Robotics. The new group seeks to promote in-depth collaboration between industry, academia and the research sector and nurture an AI ecosystem in Hong Kong and the Greater Bay Area.



Hi-tech tonic for corporate social responsibility

November brought the France-HKUST Innovation Hub's first public event when the final of the Innovation Contest 4CSRtech took place at the University campus. Eight teams sought to introduce their novel technologies and concepts to advance corporate social responsibility (CSR) in line with the UN's Sustainable Development Goals. Participants included start-up entrepreneurs, school and university students, with team members hailing from Hong Kong, Mainland China, Taiwan, and India.

Two winners were eventually chosen, including a HKUST engineering and business student team. The HKUST proposal centered on a mental health monitoring system to help companies take preventative measures to assist employees under stress. The other winning concept, by Hong Kong start-up Beelventor, involved an

integrated smart device fixed to construction workers' safety helmets to provide real-time health and safety monitoring and site management.

The France-HKUST Innovation Hub was launched in 2017 to incubate ideas and opportunities, and foster HKUST research and development partnerships in science, technology and education with French institutions and companies. The contest was co-organized with the Consulate General of France in Hong Kong & Macau and Orange Group.

Innovation Contest 4CSRtech: fostering business practices in line with sustainable development.



GREAT expectations for urban living

The recent launch of the GREAT Smart Cities Center is set to provide an interdisciplinary home for academics, industry, and government to collaborate on future city development and advances. GREAT refers to the attributes of a good future city, namely, Green, Resilient, Empowering, Adaptable and Transformative while “Smart” means the intelligence applied to these five attributes.

The Center, which held its inaugural symposium in 2018, brings together academics from a range of areas across the University to foster different aspects of smart city development and to demonstrate how such synergy can tackle problems that are beyond any one discipline. “The Center can create common ground,” said Chair Professor LO Hong-Kam, Civil and Environmental Engineering and Director of the GREAT Smart Cities Center.

Sample projects associated with the Center include enhancing walkability in Hong Kong, smart urban water supply systems, and a personalized real-time air quality informatics system for exposure (PRAISE-HK). Along with cutting-edge research, the Center strives to foster the expertise and professionals who can contribute to smart city development, facilitate policy formulation, and help develop large-scale projects and interdisciplinary collaborations.

The creation of the Center is in line with global and local developments in this area. At its first symposium, academics and professionals from Hong Kong, Mainland China, Japan, Korea, Singapore and the US offered a variety of perspectives on smart city development.



The University's smart city development platform will foster interdisciplinary advances.

Healthy development

Research on the environment, health and well-being has gained a valuable platform for translating concepts and laboratory studies into products to address community needs with the establishment of the HKUST-CIL Joint Laboratory of Innovative Environmental Health Technologies. The joint lab set up by the University and Chiaphua Industries Limited (CIL) will initially seek to translate HKUST smart disinfectants focused on HiNW light disinfection, a malodor control hydrogel, and colloidal antibacterial technology into commercial products. Lab researchers will work with government departments, non-governmental organizations, and establish a global network of research partners to further extend its reach and capabilities.

Joint AI lab launched with NAVER/LINE

HKUST has become the first university globally to set up an artificial intelligence lab with Korean internet search portal NAVER and its global mobile platform LINE. The joint lab partnership with the University's Big Data Institute will enhance research on data science and artificial intelligence through the development of algorithms, models and prototype implementations on smartphones and other mobile platforms. In addition, it will support a PhD student fellowship program and organize workshops and events.

Fresh light on displays

Coming up with a colorful solution: research team leaders Prof. Kwok Hoi-Sing (left) and Prof. Abhishek Srivastava.



Chair Professor KWOK Hoi-Sing, Electronic and Computer Engineering, and his research team have developed an award-winning liquid crystal display (LCD) that improves energy efficiency by three to five times and image resolution by three times, all for a lower cost. The advanced technology is suitable for portable electronic devices, such as smartphones and laptops, enabling their batteries to last longer. It could also be applied to virtual reality headsets and other high-end displays given the improved resolution and color performance, Prof. Kwok noted.

The technology, known as active matrix ferroelectric liquid crystal display (FLCD), can replace traditional color filters, which limit energy efficiency as they block and use up 70% of backlight and energy as well as consume 30% of display manufacturing costs.

To do so, the researchers developed field sequential color technology, using fast ferroelectric liquid crystal, to display color images sequentially. FLCD leverages human vision capabilities to fuse the fast-switching images into a full-color picture. Color saturation was enhanced by employing RGB LED in the backlight rather than LED and image resolution increased as sub-pixels for different colors were eliminated. The overall result was a cheaper yet higher-quality display.

Prof. Kwok is Director of the State Key Laboratory of Advanced Displays and Optoelectronics Technologies, which is based at the University, and Dr. William M. W. Mong Professor of Nanotechnology. He and his researchers worked on the development in collaboration with Taiwanese electronics manufacturer AU Optronics. In 2018, the team's technology received the Best Prototype award within the Innovation Zone of Display Week 2018, a leading international annual event organized by The Society for Information Display.

Centrifuge modeling upgrade to boost hazard prevention

A modular drum centrifuge facility is being developed at HKUST, with support from the Hong Kong Research Grants Council's Collaborative Research Fund. The new multi-million-dollar facility, together with the existing beam centrifuge, will form a world-leading centrifuge cluster for advanced studies in hazard prevention, offshore resource engineering, and environmental protection. These will include research into mountain and estuary hazard mitigation and simulation of long-distance landslides, debris flows and wave-induced phenomena, among others.

While HKUST's original 400g-ton beam centrifuge is capable of simulating centralized problems, such as piles, the 870g-ton, 250g, 2.2m diameter drum centrifuge can simulate distributed problems occurring over distances of up to 1,726 meters.

The facility, jointly developed by researchers from HKUST and other Hong Kong universities, in collaboration with Cambridge University and South China University of Technology, will help to keep Hong Kong at the forefront of physical modeling of geotechnical processes. It will also be available for use by industry researchers.

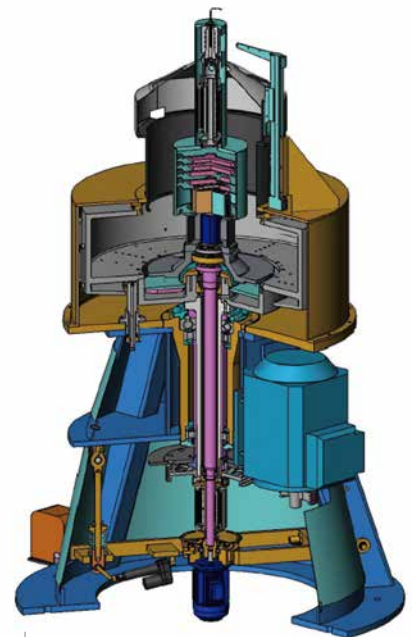

The new drum centrifuge for research into mountain and estuary hazard mitigation and environmental protection.

Cutting-edge degrees for changing times

Fall 2018 was a busy time for fresh starts at the School of Engineering with the first undergraduates taking up their studies in four innovative bachelor degree programs.

In line with the growing emphasis on multidisciplinary knowledge and skills in many of today's emerging fields and careers, the BEng in Sustainable Energy Engineering is jointly offered by the Departments of Chemical and Biological Engineering, Civil and Environmental Engineering, Electronic and Computer Engineering, and Mechanical and Aerospace Engineering. The BSc in Data Science and Technology is a cross-School undertaking by the Departments of Computer Science and Engineering in the School of Engineering and Mathematics in the School of Science.

The BEng in Decision Analytics, a significant emerging area in the knowledge economy (see P20), and the BSc in Integrative Systems and Design, a University-wide program

employing a project-based learning approach rather than a fixed curriculum, are also now underway. The former is run by the Department of Industrial Engineering and Decision Analytics while the latter is managed by the Division of Integrative Systems and Design (see P14-15).

"The School is delighted to offer undergraduates, locally and from outside Hong Kong, the chance to move into and make an impact on these key fields of tomorrow," said Prof. Philip MOK, Associate Dean of Engineering (Undergraduate Studies). "And to help them do so through leading educational approaches and a student experience that will truly make a difference to their lives – and the lives of others." (see P16).

A BEng in Bioengineering will be launched by the Department of Chemical and Biological Engineering in Fall 2019.

Spurring early interest in STEM

A novel interactive endeavor launched by HKUST is set to build the next generation of technology and science innovators by fueling interest in science, technology, engineering, and mathematics (STEM) among school students.

The STEM@HKUST One-stop Online Platform (<https://stem.ust.hk/>) provides materials to encourage young learners to investigate daily life problems in a scientific way. It also supports school teachers in their efforts to build the essential attributes of a STEM explorer, namely a critical mindset and problem-solving skills.

The website presents original videos by the University's faculty, staff, and students, which explain everyday phenomena and answer intriguing questions about how the world works. Learners and teachers can also put forward their own topics or the experiments they would like to see featured.

The platform was co-founded by Prof. WOO Kam-Tim, Founding Director of the Center for Global & Community Engagement, School of Engineering, and Prof. King CHOW, Director of the University's Center for the Development of the Gifted and Talented.

Prof. Chow noted that STEM subjects in local schools were still largely textbook and practice-oriented rather than focused on developing the thinking required to be successful in these fields. STEM education actually lies in developing students' capabilities to analyze systematically, identify a feasible solution, and evaluate the validity experimentally, he said.



Platform co-founder Prof. Woo Kam-Tim boosts interest in STEM among school students.

Robotics comes of age



Prof. Li Zexiang is an academic-entrepreneur with a mission to incubate human creative talents and next-generation companies to speed the age of smart automation

For a researcher dedicated to pushing the frontiers of machine motion and dexterity, it is fitting that Prof. Li Zexiang's own life should be one constantly on the move.

The electronic and computer engineering front-runner was among the earliest Mainland China students to study robotics as it took off in leading US research universities in the 1980s. He was a driving force behind DJI and is still the company chairman of what has rapidly become the world's largest consumer drone group, with over 70% market share. Now the indefatigable academic is again setting his sights sky high as a leading contributor to the hi-tech start-up ecosystem being powered forward in southern China's Greater Bay Area, a region comprising Hong Kong, Macau, and nine neighboring cities in the Pearl River Delta.

Prof. Li's expertise lies in multi-fingered robotic hands, precision assembly, and motion controllers, the "brains" that generate the speed and mode used to make a machine move. All are key areas for greater automation in the computer, communications and consumer electronics (3C) manufacturing industry, which has a major presence in the Pearl River Delta and forms a vital part of the global supply chain for products such as smartphones and electrical appliances.

He joined the School of Engineering in 1992 in HKUST's formative days, after 13 years exploring robotics and artificial intelligence research at Carnegie Mellon University, University of California, Berkeley, MIT and New York University. As early as 1998, he set up the University's Automation Technology Center.

At the Center, Prof. Li, his students and colleagues engage in the theoretical study of assembly processes along with the software and hardware development that can be transferred out to assist industry in the region. Projects currently underway include 3C technology to automate electronic component assembly tasks and an unmanned aerial vehicle (UAV) system leveraging cutting-edge robotics to provide auto-landing, positioning, and sensor-fusion navigation. He is also a member of the HKUST Robotics Institute, a multidisciplinary University-wide platform set up in 2015.

But the proudest of his many achievements to date, he noted, is to have helped to integrate education and research with entrepreneurship by fusing previously separate elements into a single entity. Besides DJI, companies now spun-off from the Center or Prof. Li's mentorship include QKM Technology for innovative 3C robotics solutions (2011), ePropulsion Technology for high-performance electric marine propulsion systems (2012), and Walnut Technology (2015), creator of intelligent skateboards, equipped with the world's first e-board posture control system.



Prof. Li Zexiang (left) and (above) a novel UAV system under development.

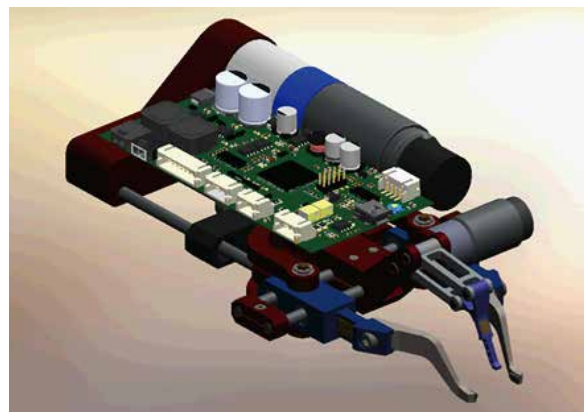

Seeking to automate electronic component assembly tasks.

From researcher to entrepreneur

Prof. Li's own realization of how the academic world could work with industry to push forward economic and social development came when a Hong Kong business person arrived at the School of Engineering in the 1990s with a real-life problem.

The industrialist had bought a machine from Japan to help with his aluminum can production line, but could not get it to do what he needed. Nor could the original manufacturer help. "Initially, I turned him down as fixing an actual machine was not really my interest or skill set at the time. But he was desperate. So I asked one of my postdocs to pull out a controller board that we had developed for a robotic hand. Then the researcher spent a month at the factory to retrofit the original controller. From then on, we began to think, how could we take our research from the laboratory and turn it into useful products for industries located around us."

Setting up Googol

In 1997, Prof. Li registered Googol Technology, a month ahead of a US company with a similar name. The business moniker was suggested by his mathematician wife from a term used by Edward Kasner, an earlier math dynamo, to represent the huge number of 10^{100} . Prof. Li later received a request for use of his company name. "We refused because we had the right spelling!"

Googol became the first hi-tech company in Asia Pacific focused on motion controllers and controller-based systems, the fundamental drivers for microelectronics, robots, computer numerical control (CNC) machine tools, production automation, and other industrial control applications. Prof. Li became one of the University's early academic-entrepreneurs. By 2008, Googol held the largest market share in its sector in China.



Prof. Li was among the first to study robotics in the 1980s, carrying out research at leading US universities.

On the move

During Prof. Li Zexiang's years as a student and researcher in the US, he undertook a host of subjects. For his bachelor degree at Carnegie Mellon University, he majored in electrical engineering and economics. On moving to the University of California, Berkeley, he pursued a master's in mathematics then a doctorate in electrical engineering and computer science. As a postdoctoral fellow at MIT, he studied artificial intelligence. On moving to New York University as an assistant professor, he worked at the robotics and manufacturing lab in the Courant Institute, founded by renowned mathematician and computer scientist Jacob "Jack" SCHWARTZ. It was Schwartz's influence that propelled Prof. Li's theoretical leanings toward application, working on multi-fingered robotic hands for automated manufacturing, among others. "That's where I got my own hands dirty," he said.

Transforming students into innovators

Meanwhile, experiential learning began to feature in Prof. Li's teaching at the School of Engineering. One of the first students to take his class providing training for the Hong Kong section of Robocon, a robotics competition organized by the Asia-Pacific Broadcasting Union, was Frank WANG Tao, later founder of DJI (see box on P13). In 2004, the first year the Hong Kong contest was held, the HKUST team did not win. But the students' interest had been fired up and the next year they did triumph, subsequently earning a place among the top three in the Asia-Pacific final in Beijing.

Frank Wang went on to utilize his Robocon experience to build an autopilot for model helicopters; and to launch DJI (see box on P13). Meanwhile, Prof. Li and the School took note of more than the contest results. It was clear that the students taking part gained hands-on experience of creating a product, from mechanical machining to how to buy components from suppliers in Shenzhen. In addition, major attributes that the successful students called upon, and developed through such learning beyond the classroom, were all key elements for innovation and entrepreneurship: persistence in the face of initial failure, big goals, and confidence that they could develop systems that were 10 times better than others.

In 2012, the School officially introduced experiential learning, which now involves hundreds of students annually in local and overseas engineering design contests and cornerstone projects.

Xbot and X-Tech

With his own entrepreneurial experiences and relentless energy, Prof. Li began to look for further opportunities to synergize human talents emerging from HKUST and other Hong Kong universities with the manufacturing ecosystem of the Greater Bay Area. In 2014, he established the Songshan Lake Xbot Park, in partnership with the Dongguan government, as an incubator for robotics and smart hardware start-ups. The park offers entrepreneurial mentorship, seed funding, and supply chain support, and has already incubated around 50 companies, drawing young businesses not only from the region

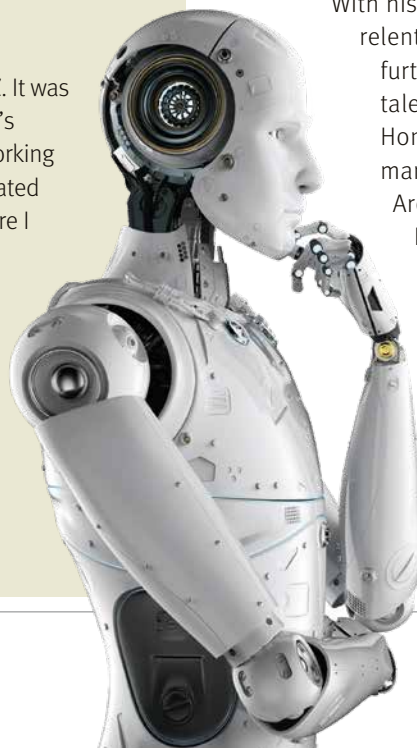



Greater Bay Area

but also from around the world. From the experience gained from this venture, Prof. Li launched the Hong Kong X-Tech Startup Platform in 2016, together with Sequoia Capital China founding and managing partner Neil SHEN and Prof. CHEN Guanhua of the University of Hong Kong.

Hong Kong and the Greater Bay Area have a great chance to be the next start-up powerhouse, according to Prof. Li. “We did a lot of benchmarking, with incubators in Silicon Valley, Beijing, and other places. Our estimate, confirmed by suppliers and chipmakers who provide support here and elsewhere, was that we are five to 10 times faster when it comes to iteration and probably one-tenth or one-fifth the cost. That is our competitive edge.”



Designs on the future: Prof. Li sees automation and robotics as a way to improve overall quality of life.

What lies ahead

To inspire the even younger generation, Prof. Li is now starting a secondary school with an emphasis on science, technology, engineering, the arts, and math (STEAM) near the University’s Clear Water Bay campus, together with the Shaw Foundation, which runs the prestigious annual Shaw Prize for the sciences.

He foresees automation and robotics as a positive way to deal with economic and social challenges arising from aging populations. There will also be more machines to add convenience and improve quality of life overall. “We are already working on areas such as construction, autonomous driving, and logistics. So you won’t see a sudden switch to a different way of living. But, after a while, people will not remember what life was like before such products were available.”

Going places

In postgraduate studies with Prof. Li Zexiang, DJI drone company founder Frank Wang continued to work on his autopilot and establishing his business. He used his early unmanned aerial vehicles, or drones, to conduct aerial surveys and damage assessment following the devastating Sichuan earthquake in 2008 and one year later succeeded in sending the first unmanned autonomous vehicle to overfly and take aerial footage of Mount Everest.

In 2011, after attending a US product show, the young entrepreneur was asked by an American aerial cinematography company to design a new kind of gimbal, a device for keeping an instrument level in a moving aircraft, to stabilize camera shots from the air. “We then saw many customers were buying the gimbal and autopilot together with a GoPro camera to create their own drone for aerial photography. DJI decided to build all-in-one consumer drones and to go it alone. We would establish our own brand name and channels,” said Prof. Li, who is chairman of DJI. “It was a lot of learning for engineering students, but Frank Wang was not afraid to do anything.”

Recently Prof. Li and Frank Wang received the prestigious 2019 IEEE Robotics and Automation Award for their unique contributions to the development and commercialization of civilian drones, aerial imaging technology, robotics engineering advancement, innovation, and entrepreneurship.



Prof. Li and then postgraduate student Frank Wang, founder of DJI, preparing for the early drone test flight over Mount Everest.

Ready for Generation Z

It's all go in the pioneering Division of Integrative Systems and Design as it prepares students to lead the way toward Industrial Revolution 4.0



Prof. C. Y. Tsui, Head of the Division of Integrative Systems and Design, with undergraduates: "I want our students to be diverse in how they apply their knowledge."

Already today, every time you jump on a plane, you are sitting inside a giant integrative system: a host of technologies that not only need to work seamlessly together but also accumulated design thinking on the best way to make people comfortable, safe, and the experience pleasant enough to encourage a return journey. Just ahead lie internet-of-things homes, filled with smart appliances and perhaps a robot helper, autonomous cars, as well as mega-complexities demanding solutions, such as climate change and eco-friendly cities.

All will require graduates who themselves serve as integrative elements, working with the insight of an engineer, scientist, business executive, economist, designer and philosopher to solve the challenges and create the 4.0 innovations to propel lives sustainably forward.

Post-millennial talents

The Division of Integrative Systems and Design is HKUST's bold response to the provision of these post-millennial human talents. Fittingly, it is designed with a distinctive style of its own, offering original multidisciplinary education with a curriculum based on a "need-to-know" basis rather than the traditional "learn this because we feel it is good for you" approach. This has led to the adoption of a project-based mode of knowledge-gathering, where students are responsible for achieving a real-world objective as a team. As a result, learners realize how certain theories and skills will help them attain that task. "Many students these days do not simply accept what is being taught. They always want to know why. This way, students see for themselves the purpose in taking courses," said Prof. C. Y. TSUI, Head of the Division. "They understand why they need to acquire specific knowledge."

The Division's name, discussed at length ahead of its launch in 2017, is particularly important, Prof. Tsui noted. "Integrated means already combined. Integrative is where you are drawing elements from others. We felt the latter was more reflective of reality – and what we wanted to do."

Education with a difference

The first undergraduate program got underway in Fall 2018 with a cohort of 14 undergraduates, who are curious, passionate about being involved in learning, and ready to collaborate. The eventual aim is 30 per year. Once students enter the Division, they find faculty members – one-third of whom are currently women – serve as coaches, "the guide on the side", rather than supervisors. Educators and researchers joining the Division are drawn from inside and outside the University, and range from robotics and human computing interface experts to embedded systems specialists. But each shares the same commitment to working in a multidisciplinary team and intensively with students.

"Integrated means already combined. Integrative is where you are drawing elements from others"

For postgraduates, the established interdisciplinary MPhil in Technology Leadership and Entrepreneurship has moved within the Division while a PhD program will also be launched. Research will be focused on the design and optimization of integrative systems and design methodologies. Social impact, not just publications in highly ranked journals, will also be an important part of the research agenda.

Design mindset

Developing a traditional design school focused on areas such as industrial design or product design is not the Division's aim, Prof. Tsui said. "What we want to do is embed the designer's holistic way of looking at a project – how to define the problem with the end user in mind, empathize with the user, look at the overall social implications – into innovation and technology education. In this way, students will know how to construct and integrate systems and processes in line with social needs."



One-third of the Division's faculty are female: (from left) Ms. Luisa Mok, Dr. Carrie Ling and Dr. Winnie Leung.

Working with companies is a must for students to gain real-world experience. An industrial consortium is set to provide the problem-based projects that learners will tackle. Academic exchange partners with institutions that have like-minded programs are also being put in place to provide overseas insights.

Another adventurous aspect is that the Division is not just focused on one School domain, even though it is managed by the School of Engineering. Instead, it is envisaged that the intake and program will extend University-wide, given that students in all fields in a world of melting boundaries can benefit from learning to work together to overcome the challenges facing Generation Z and beyond.

Harmony in diversity

Prof. Tsui, who recently finished a four-year term as Associate Dean of Engineering (Undergraduate Studies), views his new role as both a challenge and exceptionally meaningful. The outcome he seeks is for a spectrum of graduates equipped with design and system thinking, communication skills, creativity and an entrepreneurial mindset who will prove irreplaceable in a world of rising artificial intelligence and robotics.

"Our students will be able to contribute in different ways as entrepreneurs and innovators, or by helping to transform a company's culture from within, or helping those in need in society. Although we are dealing with integrative systems, I want our graduates to be diverse in how they apply their knowledge. And to possess a human edge that machines cannot replace."

An education that recognizes individual needs and talents can propel students to excel as engineers, explains Prof. Philip Mok

Learning to unlock potential



Prof. Philip Mok enjoys spurring students' enthusiasm for engineering.

Motivation is the key to a good education, notes Prof. Philip K. T. MOK, who recently took up the post of Associate Dean of Engineering (Undergraduate Studies). The student-centered educator views teaching as a quest to find what fires up undergraduates' interest in engineering, recognizing that individuals differ in their capabilities and outlooks, and such differences need to be taken into account. That takes patience and persistence. But it is certainly worth it, Prof. Mok believes, when the outcome is next-generation dynamos as filled with enthusiasm for your subject and engineering as you are.

Integrated vision

Indeed, after a career first launched in the Department of Electronic and Computer Engineering in 1995, Prof. Mok (PhD, University of Toronto) still radiates an abundance of zest for his field, where the IEEE Fellow focuses his energies on semiconductor devices, integrated circuit design, and power management. When he joined HKUST, only founded in 1991, it was a new university with a research focus, a dynamic and enterprising culture, and a young and energetic faculty. This meant Prof. Mok could focus on teaching and research at the same time, contributing both to the community's future talent pool as well as innovation. Currently, he also heads the University's Integrated Circuits Design Center. On the education front, he is a three-time winner of the School of Engineering's Teaching Excellence Appreciation Award.

Productive learning

He views School of Engineering education as offering a productive variety of cutting-edge learning experiences, such as flipped classrooms, experiential learning, local and international student competitions, and undergraduate research opportunities. Such an approach creates flexibility and caters to students with different interests and potential. The timely introduction of new degree programs that answer society's evolving needs, and as fields emerge, is an equally important feature.

"It is only if you find and follow your passion that you will excel"

To help young engineers discover their true interest – and hence their self-motivation – he urges students to be curious, confident, always ready to learn new knowledge, and to verify the know-how they acquire. "It is only if you find and follow your passion that you will excel."

He is also keen to see School of Engineering graduates aspire to improve people's lives. Take his own specialization in power management, for instance, which involves green electronics to use energy efficiently, minimize wastage and conserve the environment. "Engineering is essentially an applied science to benefit mankind," he said.

Prof. Richard So welcomes the growing scope for the School's postgraduates and researchers

Hong Kong takes off as innovation hub

Prof. Richard So (above), and discussing modeling human auditory responses with former student-turned-entrepreneur Calvin Zhang.

As science and technology innovation moves to the strategic forefront in Hong Kong and southern China, the School of Engineering is actively seeking to optimize emerging opportunities for faculty, students, and graduates, says Prof. Richard H. Y. SO, who became Associate Dean of Engineering (Research and Graduate Studies) in July 2018.

From research to impact

Consistently high rankings* in global league tables provide recognition of the quality of research carried out in the School's comprehensive engineering remit. Now the HK\$50 billion investment in innovation and technology announced in Hong Kong's 2018 budget, openings in the Greater Bay Area, and alliances to access new countries to attract top talents, are some of the ways that the School can keep moving ahead, he said. "We have to help colleagues grasp these chances, translate basic research into impact, and establish stronger links with industry to achieve win-win situations for both HKUST and Hong Kong."

"He is thrilled to see a research and development culture unfolding in Hong Kong"

A highly successful researcher himself, Prof. So (PhD, University of Southampton) joined the Department of Industrial Engineering and Decision Analytics in 1995. He specializes in ergonomics, human factors, and functional

brain studies, with a focus on human visual and auditory systems and bio-inspired smart algorithms. His research has been applied to innovative hearing aids which isolate desired sounds from unwanted noise. Another invention aims to prevent virtual reality users from feeling dizzy, a phenomenon that affects one-third of people after prolonged exposure. He also became the first in Hong Kong to be elected a Fellow of the International Ergonomics Association in 2014, an honor held by less than 100 people worldwide at the time of his election.

R&D impetus

Prof. So is thrilled to see a research and development (R&D) culture unfolding in Hong Kong, with his PhD and postdoctoral students now starting to find positions available in local start-ups and expanding options for technology and science-related careers in the city. "Asian companies, including those in Mainland China and Hong Kong, are gradually building their own R&D divisions, and this positive trend is spreading to small and medium-sized enterprises," he said.

Excitingly, once R&D directors and chief scientists start to be hired, he foresees Hong Kong will be able to retain its scientific and technological talents as the job openings, career ladder, and leadership will finally be there.

* E.g. QS World University Rankings by Subject 2018: Engineering and Technology: No.17. More School rankings details: <http://bit.ly/2BBo9XK>

Bridging the gender gap

The Asian Deans' Forum 2018 – The Rising Stars Women in Engineering Workshop took place at HKUST over four days in October, bringing together PhD candidates and early career female professionals from different engineering disciplines and institutions around the world to explore and discuss careers in academia and the development of women academic leaders in Asia.

The workshop, held for the first time in Asia, attracted 245 applicants, with 28 shortlisted to take part. Twenty-two other participants were nominated to join by their institutions. Attendees came from Harvard University, Imperial College London, ETH Zurich, and Massachusetts General Hospital, among other institutions.

Asian Deans' Forum 2018 THE RISING STARS WOMEN IN ENGINEERING WORKSHOP 4-7 OCT 2018 | HKUST, HONG KONG

International panel discussion
with engineering academics.





Workshop participants enjoy HKUST life.



Visionary nanotechnologist Prof. Evelyn Hu (Harvard).

Member organizations of the Asian Deans' Forum collaborating in the event together with HKUST included National Taiwan University, National University of Singapore, Seoul National University, and the University of Tokyo. The workshop was co-sponsored by the University of New South Wales.

Guest of honor at the opening ceremony was Hong Kong principal official Ms. Teresa CHENG, Secretary for Justice, who officiated with HKUST President Prof. Wei SHYY, Dean of Engineering Prof. Tim CHENG, and other Asian Deans' Forum representatives. In her plenary remarks, Ms. Cheng, a senior counsel and also a chartered engineer, noted the under-representation of women in engineering in many areas of Asia and praised the workshop for drawing attention to the openings that existed in the region for top young female engineering academics.

Keynote speeches by established women engineers in academia encouraged female scholars to pursue engineering research and teaching careers, discussing how to optimize life in academia, build a strong research group, and become a faculty member, along with knowledge transfer and work-life balance. Panel discussions, mentoring, and meetings with deans and department heads of participating universities also formed part of the line-up.



Career mentoring ...



... and being enthused about engineering opportunities.



Meeting of minds: the Asian Deans' Forum is a gathering of engineering heads of member institutions to share experiences and foster development of leading engineering knowledge, research, and academic human resources in Asia.



Rising Star participant Dr. Sisi Jian is set to join the Department of Civil and Environmental Engineering at HKUST following the workshop.



Prof. Guillermo GALLEGO is Department Head and Chair Professor of the Department of Industrial Engineering and Decision Analytics and Crown Worldwide Professor of Engineering. He has published influential papers on dynamic pricing and revenue optimization, supply chain management, discrete choice modeling, and demand and supply analytics. He works closely with global companies and government agencies.



Watch the video exploring the Department of Industrial Engineering and Decision Analytics.

The rise of decision analytics in the knowledge economy

By Prof. Guillermo Gallego

Students seeking careers in the service sector should seriously consider the new opportunities emerging in the knowledge economy, where growth depends on information and its effective use to solve societal problems.

One key area is decision analytics. This involves analysis of data (including statistical and machine learning techniques), simulation, modeling, and prescriptive analytics tools to support measurably better decisions for companies and governments.

The field has its roots in several disciplines. It borrows from industrial engineering its contributions to manufacturing and logistics. Management science provides some of the modeling background while operations research supplies optimization methodology, simulation, and stochastic processes. Many of these disciplines were developed at a time when data were scarce and computing power expensive. The current abundance of data and tremendous advances in computer power make it possible to merge these disciplines with statistical and machine learning, and artificial intelligence to support decision making in the knowledge economy.

As an example, data collected from consumers' choices can help companies design and price products and services to improve profits and capacity utilization while providing consumers with products that are better aligned with their needs.

“Decision analytics supports companies and governments in making measurably better decisions”

Take the travel and leisure industry. The airfare for the same flight on the same departure date will experience price fluctuations that are influenced by the booking date (number of days before departure), travel restrictions (such as Saturday night stay, or returning within 30 days), ancillary services included (luggage handling, boarding priority, advance seat assignments, mileage accrual, and others), remaining capacity and expected demand. The intelligent design of fares (restrictions and ancillary services) together with dynamic pricing often results in a win-win for airline companies and consumers who travel for leisure or for business. Airlines can boost revenues, while consumers can purchase tickets that better fit their travel intentions (for example, bundling discounts for tickets and hotel rooms for the leisure segment and providing availability for last-minute tickets for those who travel for business).

Decision analytics leverages data, modeling and analytics to support companies and government organizations in making more informed decisions. At HKUST, our Decision Analytics program provides students with a range of flexible problem-solving skills that can be applied in different areas, including fintech, financial engineering, consulting, risk management, healthcare, as well as logistics and advanced manufacturing.

This is the future trend where decision analysts are present in companies to maximize profit margins, improve overall consumer experience and better utilize scarce resources.

**First multidisciplinary program of its kind
in Hong Kong and Mainland China**



MSc in Financial Technology

Time to make your move into the burgeoning field of FinTech

With the HKUST Master of Science in Financial Technology, you get to learn the business insights, engineering principles and mechanisms, and quantitative techniques needed to analyze and employ new and emerging financial technologies. All in one program.

**“Find out how to combine
novel technologies and
innovation to improve
financial services”**

Prof. Cai Ning
Program Director

Build your competitive edge

AI, blockchain, corporate finance, data analysis, data mining, decision analytics, and more...

Run jointly by the School of Business and Management, School of Engineering, and School of Science.

First intake in Fall 2019.

Application deadlines

February 1, 2019 (Full-time, one year)

April 1, 2019 (Part-time, two years)

Applications now open

Admission on a rolling basis

School of 理學院
Science

 工學院
SCHOOL OF
ENGINEERING

 **HKUST**
BUSINESS SCHOOL
香港科大商學院
WORLD CLASS IN ASIA

More details





Main picture:
Full speed ahead
for the winning car.



At the planning stage.



In the frame.



Under construction.

Driving forward the future

There was an early introduction to life in the fast lane at the School of Engineering (SENG) when over 40 secondary school students set to work on building – and later driving! – their own electric vehicles on campus.

The four-day summer program brought together students from Queen’s College, Tseung Kwan O Government Secondary School, Immaculate Heart of Mary College, St. Mary’s Canossian College and HKTA Tang Hin Memorial Secondary School. It was co-organized by the Academy for Bright Future Young Engineers, established under the School, and CLP Holdings Limited.

Working in teams and assisted by SENG undergraduates and staff, participants sought to build an operable vehicle, vying to outshine other cars on aesthetics, engineering and overall performance. They also visited CLP’s electric vehicle fleet and the CLP Power Low Carbon Energy Education Centre.

At the end of the program, the championship was awarded to Immaculate Heart of Mary College for being the quickest to complete laps of the track in their vehicle. Team leader HO Ching-Kan said they had learned a great deal about cooperation from the teamwork involved, from the allocation of jobs to suit members’ different abilities to recognition of the importance of communication. Although each day had its challenges, taking their electric car finally out on the track was “really exciting”, he said.

The Academy for Bright Future Young Engineers is funded by the Bright Future Charitable Foundation, founded and chaired by Prof. Roy CHUNG. The student-centered platform seeks to bring authentic, innovative, hands-on engineering experiences to high school learners and to inspire them to embrace an engineer’s mindset. Following an initial donation in 2016, Prof. Chung recently pledged a further gift to support the Academy for another two years.

Prof. Chung also joined the judging panel for the electric vehicle program contest. Other judges included Dean of Engineering Prof. Tim CHENG, Senior Advisor – Strategy, CLP Power, and Director of Smart Charge Mr. CHOW Tang-Fai, and Associate Professor of Engineering Education and Associate Director of the Academy for Bright Future Young Engineers Prof. Ben CHAN.



A touch of color.



Ready to roll: (from left) contest judges Prof. Tim Cheng, Prof. Roy Chung, Mr. Chow Tang-Fai and Prof. Ben Chan.

The Dream Team

WU Aoyu

MPhil in Computer Science and Engineering (2019)
BEng in Electronic Engineering,
and in Computer Science (2017)

Pulse Crowd Flow Platform

When assessing my postgraduate options following my undergraduate studies, HKUST continued to stand out because of its academic reputation in engineering and tranquil environment – an ideal place to avoid hectic city life and concentrate on learning. It is, though, impossible to truly escape crowds in Hong Kong and, given the University’s increasingly high profile and booming enrolment, space issues have sometimes arisen at campus facilities such as the canteen. But you can never be sure when!

Fortunately, during my undergraduate studies, I had learned the benefits of being comfortable in handling data. I decided to make a change –

Three School of Engineering students discuss how they are activating their individual ideas for hi-tech change

using a data-driven approach. My vision was a real-time platform that could collect, analyze, and communicate information to let the University community know the busy-ness of various locations and better plan their time. For example, when to eat given the current numbers of people in the restaurants.

First, I teamed up with my MPhil classmate Steve KU Bon-Kyung and other students. Then, after gaining permission from the University’s Information Technology Services Center, we started to explore wi-fi access data, which offered a reliable estimation of crowded areas on campus. Under the supervision of big data analysis and visualization expert Prof. QU Huamin, Computer Science and Engineering, we developed techniques to analyze the situation at different places, such as the waiting time at bus stops and available seats in food outlets, and built an appealing public interface to relay the information.

However, even the greatest of prototypes can be far from what is needed in a real application. The chance to move forward arose when working with the School of Engineering on our demonstration of the “Pulse” platform for HKUST’s Information Day, a popular annual event introducing the University to potential undergraduates and their families. Using staff members’ feedback prior to the occasion, we were able to optimize Pulse to cater to user needs and display real-time crowd distribution, movement, and the status of various campus facilities on the large overhead screens in the Engineering Commons. Added convenience for the campus community and a live showcase of HKUST technology for visitors!

We now plan to add new data sources, such as cameras, to improve facility status data. Meanwhile, we are aiming to make Pulse more widely available via the University’s visitor center and “USting” app, which provides handy mobile access to different student services. As part of HKUST’s newly launched Sustainable Smart Campus initiative, I also hope our work will contribute to a more connected campus.

Wu Aoyu in front of the Pulse platform, which shows whether campus facilities are busy or not.



Leslie LEE Chun-Hei

BEng in Computer Engineering (2020)

Smart Car

I became fascinated by robots as a child when I saw futuristic movies where incredible advanced machines would be shown helping people have a better life. From those films, I began to see how robots could serve a useful role in society, taking on routine or dangerous manual jobs such as household chores or construction work, and allowing people more flexibility and a higher quality of life. Since then it has been my dream to build a robot that can benefit the world.

First Class Award

Quad-Wheel Photoelectric Category
(NXP Cup Intelligent Car Racing Competition
(South China Region) 2018)

After high school, I applied to the School of Engineering as the HKUST Robotics Team is widely known to be one of the strongest in Hong Kong, possessing extensive knowledge of robotics development and winning many external competitions.

In my two years as a member of the team, I have been involved in the smart car competition, which focuses on developing an intelligent autonomous vehicle. I was interested in this kind of robotics technology as it is likely to assist smart city development. The introduction of autonomous transportation, for example, should lead to greater efficiency, easing traffic congestion. It should also improve safety, as accidents are often caused by human error.

Leslie wants to build more robots in the future.



Leslie Lee and his teammate drive their knowledge forward.

Initially, I didn't know much about constructing a smart car, but with senior students' help, and my own research, I learned the basic software, hardware, and mechanical design needed. These three aspects represent the soul, heart and architectural body of such a robot; and to build a fully functioning vehicle, I knew none could be ignored. However, in my initial year, there wasn't time to learn every aspect. Members of the team then divided the tasks (mine was hardware) and rigorously studied and trialed what we learned in our respective areas. Later, we pooled our understanding and successfully worked together to complete our entry for the competition.

After this first event, I discovered some flaws with my approach to learning. I realized that stopping my research after finding out the basics led to mistakes while building the robot, as my knowledge wasn't deep enough. After that, I changed my strategy, trying to dig out every piece of helpful information and not stopping until I thoroughly understood the material.

In the next competition, we won a first class award, becoming the first team in Hong Kong to do so in this event! I now believe one day I will be able to build my dream robot to save people in dangerous occupations from undertaking such work.

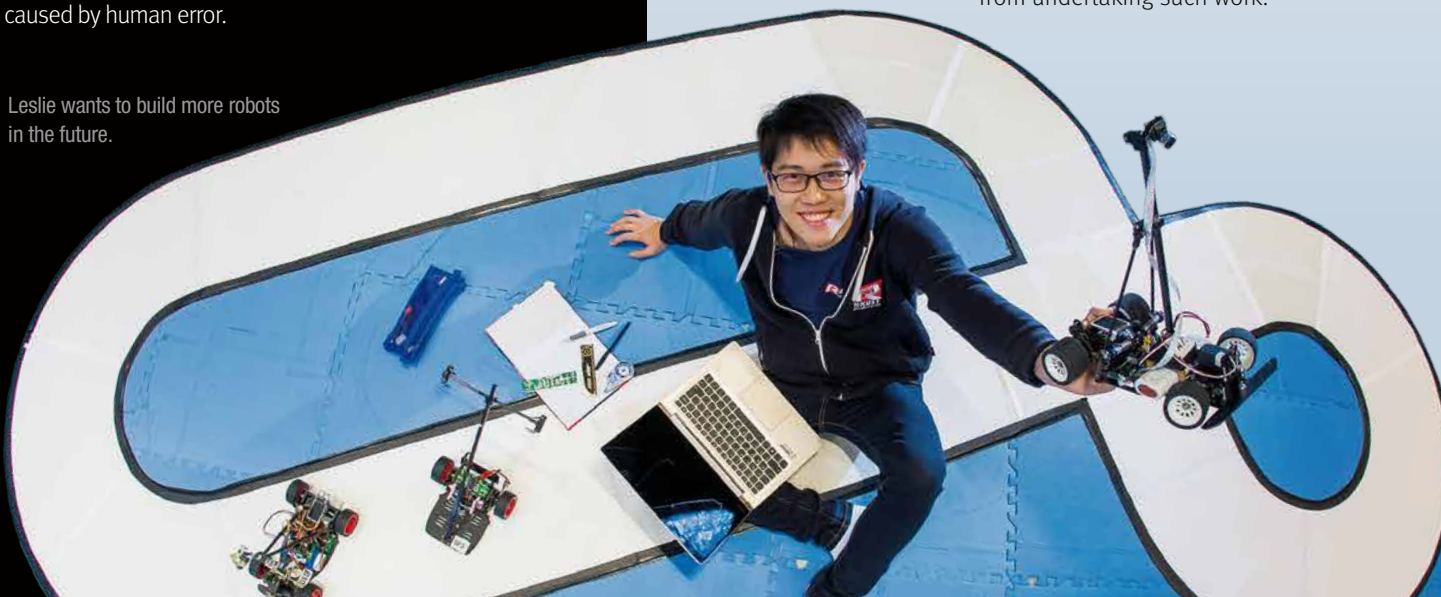

Kenneth AU Chun-Ming

MPhil in Computer Science and Engineering (2019)

BEng in Computer Science (2016)

UMix Music App

I have had a strong interest in engineering, in particular software design and development, since I was young. I also love composing and producing pop music. The best tools for this second passion of mine are usually tailored for desktops. Indeed, in the past, trying to produce music on a mobile system has been a terrible experience. The smartphone UMix music app is my answer to that, a platform started together with fellow MPhil student Benjamin LAI whose enthusiasm for engineering, product design, and design thinking combines really well with my own outlook and abilities.

The ultimate goal of our UMix music app is to let everyone create music easily, irrespective of age, background, and musical preferences. To do this, we needed to acquire the relevant development knowledge and skills in computer music, digital signal processing, and artificial intelligence technology to come up with innovative audio processing algorithms that could accurately convert a voice to MIDI (a protocol for recording and playing back digital music supported by personal computer sound cards). This provided an intuitive way for users to compose simply by humming tunes, which could then be turned into different instrumental sounds, such as an acoustic guitar or flute, and mixed together.



As HKUST has a great ecosystem for developing your own ideas, there were many opportunities for Benjamin and me to participate in engineering projects to acquire those skills as well as robotics and software design understanding, build our hands-on experience, and broaden our engineering thinking to encompass design and business perspectives. All this helped us to win a high-profile Hong Kong ICT award in 2018 and, at the same time, turn our UMix music app into a start-up company.

Student Innovation Grand Award

(Hong Kong ICT Awards 2018)

As a result of this amazing journey, our problem-solving skills have greatly increased. Many of the challenges we encountered along the way had no absolute answer. We simply had to keep thinking, trying, failing, evaluating, and trying again to overcome hurdles, whether researching and developing algorithms, designing the user interface, building the mobile app, working on business plans, or seeking funding.

It further showed us that studying engineering is not limited to acquiring theoretical knowledge but also involves practical application of problem-solving skills to real-life issues. The School of Engineering certainly offers students the environment and exposure to enjoy many valuable opportunities to explore and advance in both areas.

Sounds great: mobile app creators Kenneth Au (left) and Benjamin Lai.



Full speed ahead for first-year students

School of Engineering new arrivals had a great opportunity to immediately try out their design and build skills on entering the School in Fall 2018 by constructing a chemical battery-powered vehicle as part of the First Year Cornerstone Engineering Design Project Course.

In this interdisciplinary credit-bearing introduction to engineering, students learn what they need to know in online modules in electronics, programming, and mechanics early in the semester. They then bring that new knowledge to their teams to design and build a system to control their “Chem-Off Roder” and compete with other teams to see whose vehicle is the fastest, best controlled, and most stable.

The final Off-Roder includes two vehicles – the lead vehicle that pulls and controls while the trailer carries the cargo. The power for the trailer comes from a chemical battery, designed and constructed by the students, while the cargo is a cup of water. The car has to operate smoothly enough not to spill the water!

The cornerstone course is specifically designed to enable first-year students to meet faculty and more senior students from different engineering departments. The goal is to give participants deeper insights into the various fields, and subsequent careers, to help them in selecting their major at the end of their first year in the School.

The chemical battery-powered car project, first offered as a summer course for all students in 2018, replaces the previous first-year cornerstone course project focused on airship building. It is available in Fall and Spring semesters.



A student-designed chemical battery-powered vehicle in action during the summer course.

Student awards & achievements



The Robocon sub-team of the HKUST Robotics Team won the championship in the 2018 Robocon Hong Kong Contest. This was the ninth time the sub-team had received the top award since the competition was launched in 2004. Two teams from HKUST took part, Fiery Dragon and War Dragon, with Fiery Dragon becoming the overall winner. Participants had to build robots that could engage in a shuttlecock-throwing knockout competition against other teams. The contest drew a total of 12 teams from six local tertiary institutions.

A Civil and Environmental Engineering team triumphed at the 2018 TECO Technological Innovation Contest, gaining the LEKO Low-carbon Technical Award for their novel technology for low energy electrical odor control of sludge. The innovation controls hydrogen sulfide production from excess sludge and enhances dewaterability. Members of the team comprised PhD students LI Xiling, XUE Weiqi, ZAN Feixiang and ZENG Qian.



PhD students CHE Yulin and WANG Lipeng, both Computer Science and Engineering, won the championship in the 4th Alibaba Middleware Performance Challenge. The contest focused on how to deal with a “trillion messages”, simulating the real-world computational challenge of handling the annual November 11 mega sales day organized by Taobao/Tianmao online mall. Over 3,000 teams from seven countries and regions joined the competition.



Prof. David ROSSITER, Computer Science and Engineering, is an expert in software technologies and an active user of IT in teaching. He has received the best instructor award at master's degree level five times and seven teaching awards at the undergraduate level. In 2017, he received HKUST's top teaching award, the Michael G Gale Medal for Distinguished Teaching.

The broader benefits of technology in teaching

By Prof. David Rossiter

When I first came to teach at HKUST some 20 years ago, many classes still used copying as their main teaching methodology, a fundamental process dating back hundreds of years whereby students would take down words or formulas written by a teacher on a blackboard into their notebooks. Since then, things have changed greatly. Technology has evolved to a remarkable level and has been readily utilized to aid teaching and learning.

In the School of Engineering, gone is an emphasis on copying, replaced largely by an emphasis on experiencing. For example, to advance experiential learning we have encouraged the development of engineering minds through the construction of an Undergraduate Student-initiated Experiential Learning Laboratory, where students propose and construct their own innovative concepts, developed under the supervision of faculty.

Through the process of budgeting for, designing and developing their own “real-world” projects, students’ minds are much more engaged compared to the relatively soulless mechanism of copying, resulting in a better understanding and appreciation of engineering concepts. One project I supervised converted washing machines in residential halls into web-enabled devices so that students could see the status of all the machines on their phone. In this way, they saved themselves and their fellow students from carrying heavy loads of clothes on fruitless trips to laundry rooms when all the machines were in use.

“We have encouraged the development of engineering minds through an Undergraduate Student-initiated Experiential Learning Laboratory”

Meanwhile, the Massive Open Online Course (MOOC) concept of teaching has exploded, with classes taught entirely through the internet and students no longer needing to be physically in one location, such as a university. Such efforts can provide up-to-date learning materials to great numbers of students, typically for a very low fee. Now the world of engineering can be appreciated and understood by a far wider and greater range of people than just a few years ago.

For example, my own MOOC taught web programming skills. It had 130,000 students who paid at most US\$80 to take the course and, after completion, receive a certificate. One student was a dentist in war-ravaged Syria. He planned to move to Germany and was taking my course to have a skill set to offer there, as his dentistry qualifications would not be recognized. Another described herself as “a stay-at-home mom who is coding in between story time and play time”. She aimed to get a job in the field before her child had even left for school.

Inspiring examples such as these are proof of the change that MOOCs have brought to many, and of why changes in teaching methodologies are key to shaping engineers of the future.

Champion of environmental education

It's time to motivate young people to prioritize sustainability

Samantha KONG Wing-Man (2014 BEng in Chemical and Environmental Engineering) is 26 years old and knows that the future of our planet depends on her and other young people. Since graduation, the tireless environmental education champion has become involved in an expanding range of areas in order to play her part in sustaining that future – and encourage more of the next generation to join her.

In August 2018, her endeavors were recognized internationally by the North American Association for Environmental Education, Global Environmental Education Partnership, and US Forest Service, when she was named among the world's 30 top changemakers under the age of 30 in environmental education ("EE 30 Under 30").

Samantha makes her contribution in myriad ways. First, she has a full-time job in Hong Kong as an environmental engineer at SMEC Asia Limited, an international engineering and environmental consultancy.

At weekends, the energetic Hong Konger provides environmental education to build understanding of the United Nations' Sustainable Development Goals (SDGs), set in 2015. Samantha worked as a summer intern at the United Nations in New York in 2014, at the time the SDGs were being negotiated. She initiated the lessons in 2017 to encourage youngsters to create and implement action plans to achieve SDG objectives.



Samantha (front row, second right) with her fellow "EE 30 Under 30" awardees.



2014 graduate Samantha Kong is inspiring the next generation to implement sustainable living.

In its first year, her pioneering SDG Junior Ambassador Program reached out to 1,200 primary students in Hong Kong and secondary students and teachers in the Philippines, focusing on topics from clean water to affordable energy and climate action. In 2018, working in collaboration with the Hong Kong Girl Guides Association, the theme was environment, health and well-being.

She sees her city needs to work harder to change attitudes and values so as to address environmental issues, among them effective policies on recycling and waste management. But she does not intend to leave because of this. "I plan to stay to make a positive difference to my hometown."

As part of this ambition, she has continued to add to her own knowledge since her bachelor degree, earning a master's in Sustainable and Environmental Design from Chinese University of Hong Kong, and now pursuing a doctorate in Environmental Policy and Education with the University of Bristol, UK.

Meanwhile, further community activities continuously widen her impact. Samantha sits on Hong Kong government advisory panels on youth development and environmental programs, is a columnist, and social entrepreneur. "Raising awareness and inspiring others to implement the principles of sustainable development in their daily lives is the real way to create change," she said.

Constructive views

Two Civil and Environmental Engineering alumnae reflect on the joys of a career that literally builds the way ahead for the world

A photograph of two women standing on a blue metal bridge with a white mesh railing. The woman on the left is wearing a dark blue blazer, a light-colored shirt, dark blue pants, and brown boots. The woman on the right is wearing a black blazer, a blue patterned dress, and black flats. They are both smiling. The background shows trees and buildings under a clear sky.

Ready to structure the future: civil engineers Gigi Suen (left) and Jenny Yeung.

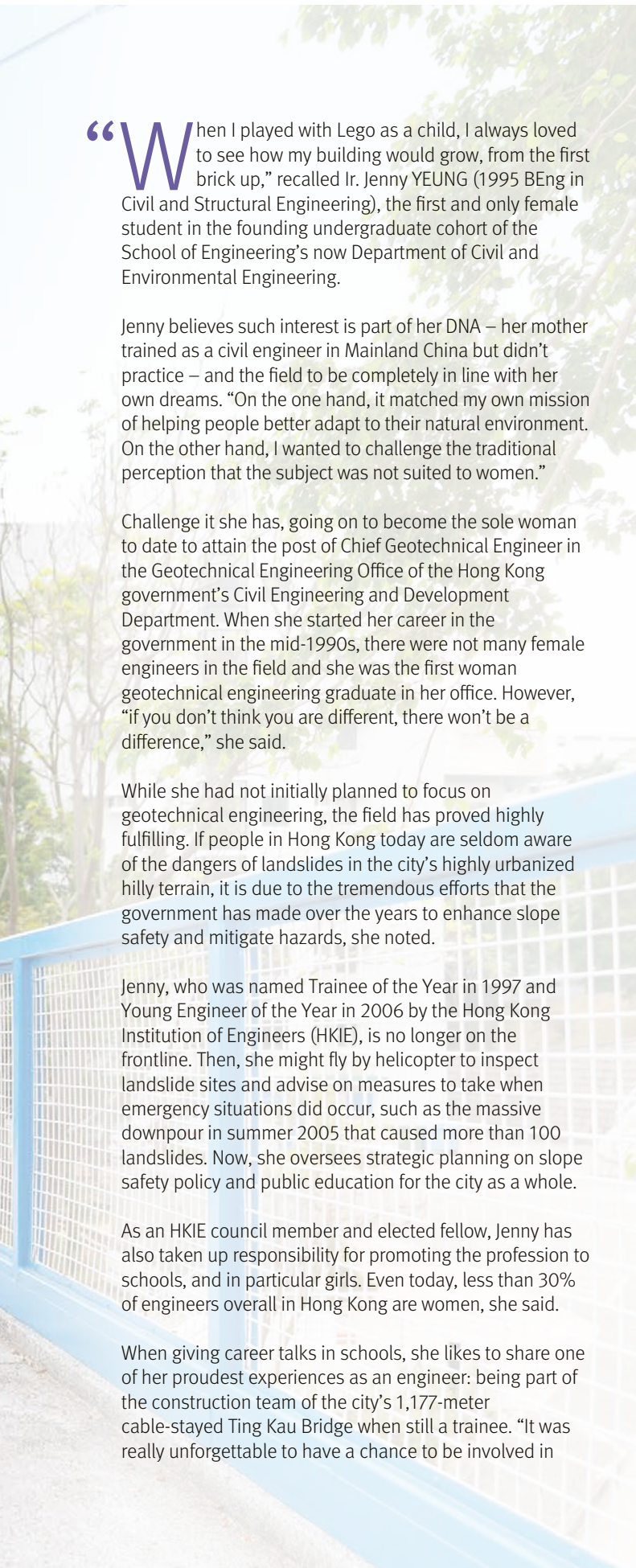

“When I played with Lego as a child, I always loved to see how my building would grow, from the first brick up,” recalled Ir. Jenny YEUNG (1995 BEng in Civil and Structural Engineering), the first and only female student in the founding undergraduate cohort of the School of Engineering’s now Department of Civil and Environmental Engineering.

Jenny believes such interest is part of her DNA – her mother trained as a civil engineer in Mainland China but didn’t practice – and the field to be completely in line with her own dreams. “On the one hand, it matched my own mission of helping people better adapt to their natural environment. On the other hand, I wanted to challenge the traditional perception that the subject was not suited to women.”

Challenge it she has, going on to become the sole woman to date to attain the post of Chief Geotechnical Engineer in the Geotechnical Engineering Office of the Hong Kong government’s Civil Engineering and Development Department. When she started her career in the government in the mid-1990s, there were not many female engineers in the field and she was the first woman geotechnical engineering graduate in her office. However, “if you don’t think you are different, there won’t be a difference,” she said.

While she had not initially planned to focus on geotechnical engineering, the field has proved highly fulfilling. If people in Hong Kong today are seldom aware of the dangers of landslides in the city’s highly urbanized hilly terrain, it is due to the tremendous efforts that the government has made over the years to enhance slope safety and mitigate hazards, she noted.

Jenny, who was named Trainee of the Year in 1997 and Young Engineer of the Year in 2006 by the Hong Kong Institution of Engineers (HKIE), is no longer on the frontline. Then, she might fly by helicopter to inspect landslide sites and advise on measures to take when emergency situations did occur, such as the massive downpour in summer 2005 that caused more than 100 landslides. Now, she oversees strategic planning on slope safety policy and public education for the city as a whole.

As an HKIE council member and elected fellow, Jenny has also taken up responsibility for promoting the profession to schools, and in particular girls. Even today, less than 30% of engineers overall in Hong Kong are women, she said.

When giving career talks in schools, she likes to share one of her proudest experiences as an engineer: being part of the construction team of the city’s 1,177-meter cable-stayed Ting Kau Bridge when still a trainee. “It was really unforgettable to have a chance to be involved in

this big infrastructure project, which took the combined endeavor of so many engineers, professionals, and workers to complete. Every time I drive on the bridge, I tell my son I was one of the team who built the bridge, and he proudly passes on the message to his friends.”

By the time Dr. Gigi SUEN (2006 BEng in Civil and Structural Engineering, 2012 PhD in Civil Engineering) joined the department in the 2000s, around 13% of the undergraduate students were women (increasing to 20% by 2018).

With mathematics a favorite subject, and Lego once again a much-loved childhood activity, she decided at an early age to pursue civil engineering as her major. After completing a PhD, she initially remained at HKUST as a researcher. However, after deciding to gain practical construction experience, she moved to a job with JMK Consulting Engineers Limited, a Hong Kong firm, in 2013.

The opportunity to shape the landscape soon appeared when Gigi became part of a structural engineering team at JMK, undertaking a variety of building projects. As work got underway, she would go on site, climbing each new floor to oversee every step of the process. “It felt amazing to see your design become a real building.” She recalled one residential development project was even featured on a property-related TV show after completion, due to its innovative design. “I was so proud,” she said.

Along with commercial buildings, Gigi has also worked on conservation and revitalization projects, such as the Former Fanling Magistracy, a Grade 3 historic building, and Tung Lin Kok Yuen, a declared monument, in Happy Valley. “It’s great to be able to understand the history of a particular old building, think deeply about how to conserve it, as well as make it meet the needs of today’s world.”

Gigi is confident that there is a great deal more for her to explore in the engineering field. And with her passion for her work, she is always happy to face challenges and manage to formulate solutions. “You don’t care about working overtime or struggling to hit a project deadline when you fall in love with your job,” she said.

Both Jenny and Gigi said they were influenced in their choice of HKUST by the world-class professors at the University and the beautiful campus. Jenny’s advice to the current generation of School of Engineering students? Be confident and proud of your status as HKUST graduates. Meanwhile, Gigi said: “Explore what you love most, and you will succeed.”

Time to reconnect

The Department of Industrial Engineering and Decision Analytics (IEDA) held two memorable get-togethers in celebration of its Silver Jubilee in October 2018. As the first alumni reunion event after the Department formally changed its name to IEDA in January 2018, over 300 alumni, students, current and past faculty members in total gathered at the University on October 13 and 20 to enjoy a series of lively reunion events.

Activities included a wonderful celebration dinner in the Chinese restaurant on campus, an IE alumni mixer, an academic workshop featuring three of the Department's overseas academic advisors as keynote speakers, and a career sharing session with five alumni sharing industry experiences with fellow alumni and students.



- 1 Faculty and alumni catch up at the IE Alumni Mixer.
- 2 Academics, alumni and students gather before the celebration dinner.
- 3 Prof. Tim Cheng, Dean of Engineering (back row, middle), Prof. Guillermo Gallego, IEDA Head (back row, first left), and Prof. Lo Hong-Kam, Civil and Environmental Engineering Head (back row, second left), with alumni.
- 4 From left: Prof. Guillermo Gallego, IEDA Head, with academic workshop speakers Prof. David Simchi-Levi, MIT, Prof. Peter Glynn, Stanford University, and Prof. John Birge, University of Chicago.
- 5 Career sharing alumni speakers Ms. Cecilia Ding, SSIF Capital Limited (first left), Ms. Michelle Bu, Morgan Stanley (second left), Dr. William Wu, ENW Electronics Limited (third right), and Ms. Ada Yan, Universal Star Education (second right), with IEDA faculty and staff. The fifth alumni speaker was Mr. Jackson Yau, Lenovo (not pictured).
- 6 Alumni with Prof. Mitchell Tseng, IEDA Founding Head, and current faculty.

Reaching out through the giving spirit

In crisis situations, it is the kindness of others that can see you through. For entrepreneur Terry TSANG Kin-Chung (2018 Master of Business Administration, 2006 MPhil in Civil Engineering, 2004 BEng in Civil and Structural Engineering), this moment occurred in 2004 with the sudden death of his father, the family's sole support, when Terry was studying at the School of Engineering (SENG). He and his brother Terence, also a SENG student, found HKUST friends, classmates and faculty highly supportive, with the University itself providing emergency funds to take the students through the difficult period.

After the Tsang brothers established their company, Madhead, and turned it into a successful mobile games business, they started to give back to HKUST, making accumulated donations of more than HK\$9 million. One of the donations was to establish a student emergency fund to help others at HKUST who suddenly find themselves in need. They have also provided support through company internships, sponsorship of student events, such as hackUST, and alumni experience-sharing.

During his recent address at the University's 2018 Congregation, Terry noted: "Giving back does not



Double happiness: Terry Tsang together with his own family and members of his HKUST family.

necessarily have to be monetary; it could be your time, or simply giving someone a helping hand. It is the little things that make a big difference. It happened to me and it can happen to anyone."

Alumni awards & achievements



An invention by **Dr. Lydia LEUNG** (2005 PhD, 2000 MPhil, 1998 BEng, Department of Electronic and Computer Engineering) received the Award of the Year at the Hong Kong Information and Communications Technology (ICT) Awards 2018 and Red Dot Design Award 2018 in Germany. Dr. Leung's Belun™ Ring is a medical device for assisting with pre-screening of obstructive sleep apnea. The ring gained the top ICT award after winning both the Smart Living Grand Award and ICT Startup Grand Award. The ring also received the 2018 Asia Pacific Information and Communications Technology Alliance (APICTA) Winner Award in the Inclusions and Community Services – Well-being category.

Dr. ZHANG Jie (2009 PhD in Civil Engineering) (pictured far right), Associate Professor of Geotechnical Engineering at Tongji University, and **Dr. ZHANG Lulu** (2005 PhD in Civil Engineering), Professor of Civil Engineering at Shanghai Jiao Tong University, were selected as Changjiang Young Scholars by the Ministry of Education.



Industrial Engineering and Decision Analytics (IEDA) PhD alumni **LI Yanting** (2008) (pictured) and **SHU Lianjie** (2002), together with Prof. Fugee TSUNG, IEDA, won the 2018 IISE Transactions Quality & Reliability Engineering Best Application Paper Award. The winning publication was focused on "A False Discovery Approach for Scanning Spatial Disease Clusters with Arbitrary Shapes".

Faculty awards & achievements

Professor Emeritus **Prof. Vladimir CHIGRINOV**, Electronic and Computer Engineering, received the 2018 Slottow-Owaki Prize from the Society for Information Display. Prof. Chigrinov was cited for his educational achievements in liquid-crystal devices. The prize is awarded for outstanding contributions in the education and training of students and professionals in the field of information display.



Prof. Anthony LEUNG, Civil and Environmental Engineering, was recognized with the 2018 International Award for Innovation in Unsaturated Soil Mechanics from the International Society for Soil Mechanics and Geotechnical Engineering. He received the award for his innovation and scholarship in the novel development of thermo-active pile rows for enhancing winter resilience of infrastructure embankments.

Prof. LIU Ming, Electronic and Computer Engineering, received the IROS Toshio Fukuda Young Professional Award at the 2018 IEEE/RSJ International Conference on Intelligent Robots and Systems (IROS 2018). The honor recognizes individuals who have made significant early career contributions with major impact on the field.



IAS Bank of East Asia Professor and Chair Professor **Prof. TANG Ching-Wan**, Electronic and Computer Engineering, was a recipient of the 2018 C&C Prize from the NEC C&C Foundation in recognition of his discovery and pioneering development of thin-film organic light-emitting devices and advancement of the organic electronics industry.

Cheong Ying Chan Professor of Engineering and Environment and Chair Professor **Prof. ZHAO Tianshou**, Mechanical and Aerospace Engineering was awarded the Scientific and Technological Progress Prize from the Ho Leung Ho Lee Foundation. The award recognizes his achievements in energy-efficient technologies and clean renewable energy storage devices and systems.



Three School of Engineering professors have been elected fellows of prominent international societies in their respective fields. **Prof. FAN Zhiyong**, Electronic and Computer Engineering, has become a Fellow of the Royal Society of Chemistry for his major contributions to the field. **Prof. Ravindra GOONETILLEKE** (pictured, top left), Industrial Engineering and Decision Analytics, has been made a Fellow of the International Ergonomics Association, a distinction that recognizes extraordinary or sustained superior accomplishments by an individual in the field. Fang Professor of Engineering and Chair Professor **Prof. LAU Kei-May** (pictured left), Electronic and Computer Engineering, was named an Optical Society of America Fellow for her outstanding contributions to photonic devices.



Chair Professors **Prof. Jang Kyo KIM** (pictured, top left) and **Prof. ZHAO Tianshou**, both Mechanical and Aerospace Engineering, and **Prof. FAN Zhiyong** (pictured left), Electronic and Computer Engineering, were named 2018 Highly Cited Researchers by Clarivate Analytics.

Prof. Matthew MCKAY, Electronic and Computer Engineering, and **Prof. Angela WU**, Chemical and Biological Engineering, were among the forward-thinking academics under 40 to be named a World Economic Forum Young Scientist in 2018. Prof. McKay uses big data and modelling to explore intelligent vaccine design. Prof. Wu is a bioengineer studying genetic information in individual cells to increase knowledge of biological systems, including cancer and embryonic development. Young Scientists are selected for their contribution to advancing scientific frontiers and integrating science into society.

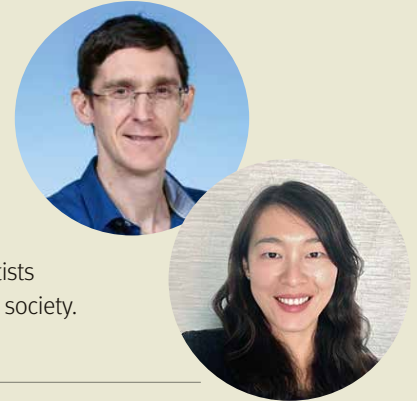

New appointments

Administrative

Prof. Joseph LEE Hun-Wei

Appointed Senior Advisor to the President
Professor Emeritus and Visiting Professor, Civil and Environmental Engineering

Prof. NG Ka-Ming

Appointed General Director of the HKUST Fok Ying Tung Research Institute
Professor Emeritus and Visiting Professor, Chemical and Biological Engineering

Prof. Philip MOK Kwok-Tai

Appointed Associate Dean of Engineering (Undergraduate Studies)
Professor, Electronic and Computer Engineering

Prof. Richard SO Hau-Yue

Appointed Associate Dean of Engineering (Research and Graduate Studies)
Professor, Industrial Engineering and Decision Analytics

Prof. QIU Huihe

Appointed Head of Department of Mechanical and Aerospace Engineering
Professor, Mechanical and Aerospace Engineering

Prof. TSUI Chi-Ying

Appointed Head of Division of Integrative Systems and Design
Professor, Electronic and Computer Engineering

Faculty Members

Prof. CHEN Qifeng

Assistant Professor, jointly by Computer Science & Engineering and Electronic & Computer Engineering
PhD – Stanford University

Prof. Becki KUANG Yi

Assistant Professor, Chemical and Biological Engineering
PhD – Brandeis University

Dr. Carrie LING

Senior Lecturer, Integrative Systems and Design
PhD – The Hong Kong Polytechnic University

Prof. Terence WONG

Assistant Professor, Chemical and Biological Engineering
PhD – Washington University in St. Louis

Prof. Allen WU

Assistant Professor, Industrial Engineering and Decision Analytics
PhD – Northwestern University

Prof. YANG Jiachuan

Assistant Professor, Civil and Environmental Engineering
PhD – Arizona State University

Prof. YEUNG Sai-Kit

Associate Professor, Integrative Systems and Design
PhD – The Hong Kong University of Science and Technology



All ready to pursue greater connectivity...

Looking ahead together

SENG Alumni Day in summer 2018 broadened knowledge of future development in the Greater Bay Area and strengthened ties between School of Engineering (SENG) graduates through two well-attended events in Shenzhen.

Over 160 participants joined the HKUST SENG-SRI Forum at the HKUST Shenzhen Research Institute (SRI). The informative forum and panel discussion focused on Greater Bay Area opportunities and HKUST's role. Speakers included President-designate Prof. Wei SHYY, Mr. Albert WONG, Chief Executive Officer of Hong Kong Science and Technology Parks Corporation, and Mr. Johnsheen ZHANG, President of Shenzhen Micro & Nano Research Institute of IC and System Applications.

This was followed by a highly enjoyable alumni reunion dinner with over 280 HKUST and engineering alumni, faculty and staff catching up with each other and building new connections.

Seven of the School's department and program-related alumni groups together with the HKUST Alumni Association and HKUST Mainland Alumni Association took part in the day's activities.

Who was there?

SENG alumni from the following groups were among those attending the events in Shenzhen:

- Civil and Environmental Engineering Alumni Association
- Civil and Environmental Engineering Postgraduates and Scholars Association
- Computer Science and Engineering Alumni Association
- Mechanical Engineering Graduates' Association
- Master of Science in Engineering Enterprise Management Alumni Association
- Master of Science in Telecommunications Alumni Association
- Master of Technology Management Alumni Association



... strong School ties...



... lasting friendships, and enjoyable times.